

GDP300-360EF

Counterbalanced Forklift Trucks

30,000 / 33,000 / 36,000 lb

- Optimal productivity with low fuel consumption
- Outstanding maneuverability to meet the demands of tough application in lumber, concrete and heavy cargo industries
- Designed for versatility with multiple attachments including tire handlers, paper roll clamps and concrete clamps



Truck Dimensions

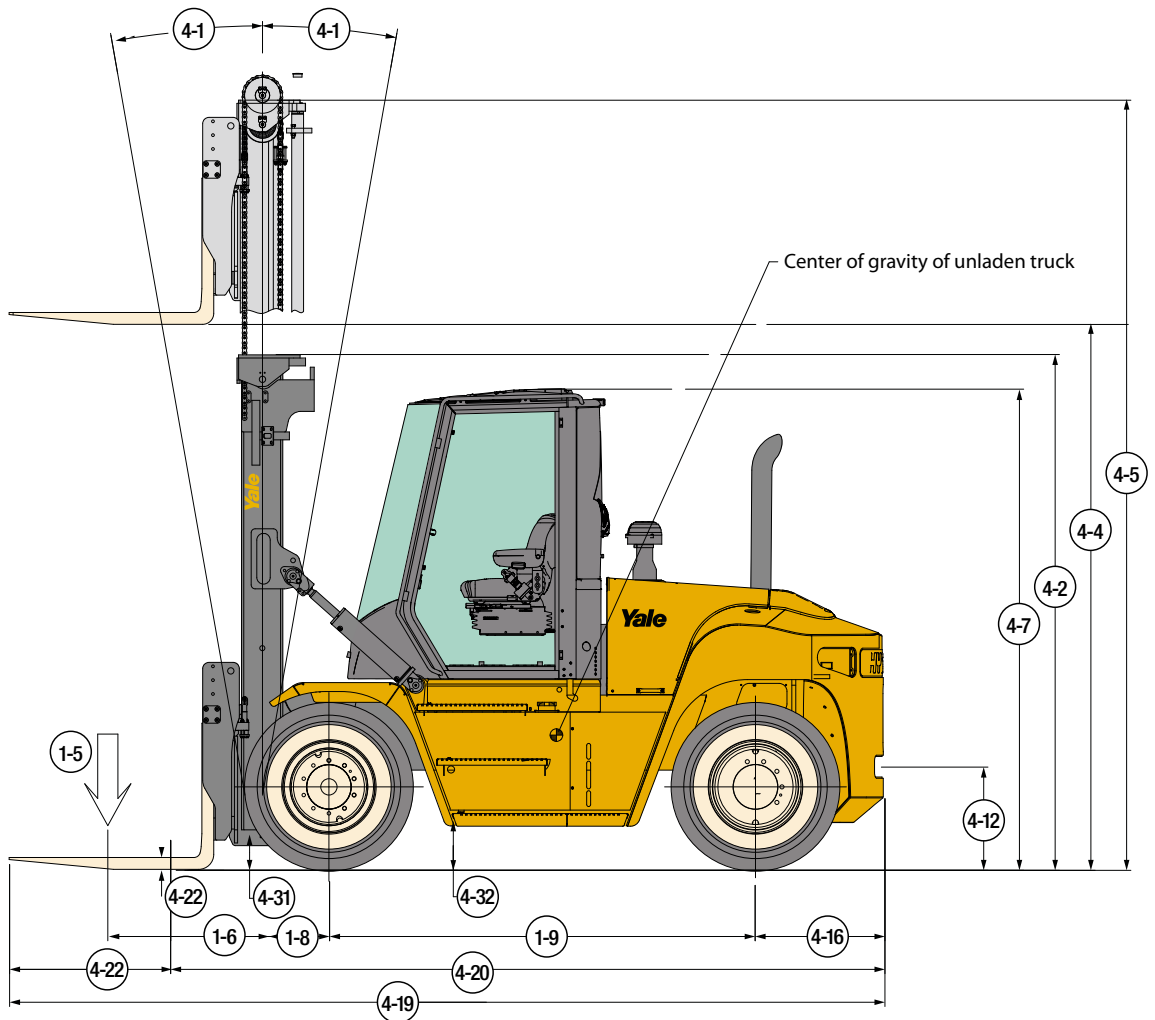
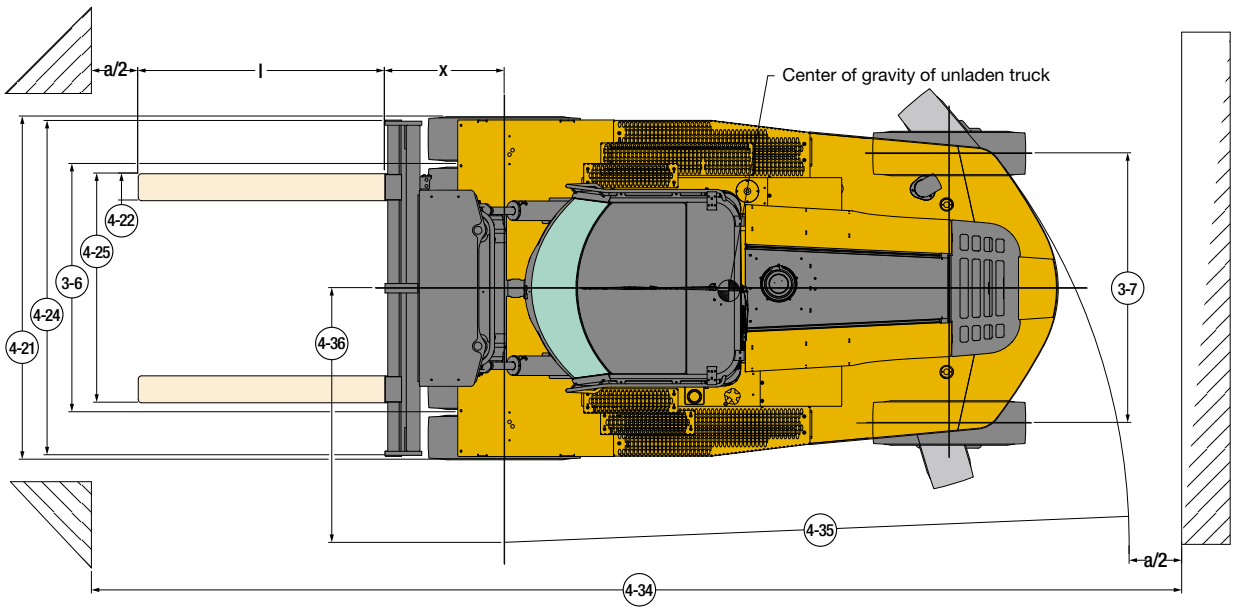

General Specifications GDP300EF / GDP330EF

						YALE				YALE				
						GDP300EF				GDP330EF				
GENERAL	1-1	Manufacturer												
	1-2	Model designation												
	1-3	Powertrain / drivetrain				Diesel				Diesel				
	1-4	Operator type				Seated				Seated				
	1-5	Rated capacity / rated load	Q	lb	kg	30,000		13,608		33,000		14,969		
	1-6	Load center distance	c ₁	in	mm	24		610		24		610		
	1-8	Load distance	x	in	mm	35		889		35		889		
	1-9	Wheelbase	y	in	mm	130		3,300		130		3,300		
	WT.	2-1	Service weight		lb	kg	39,328		17,839		41,103		18,644	
2-2		Axle loading with load, front / rear		lb	kg	64,122	29,085	5,206	2,362	68,444	31,046	5,658	2,567	
2-3		Axle loading without load, front / rear		lb	kg	20,498	9,298	18,830	8,541	20,459	9,280	20,644	9,364	
WHEELS	3-1	Tire type				Pneumatic				Pneumatic				
	3-2	Tire size, front				12.00-20 20PR				12.00-20 20PR				
	3-3	Tire size, rear				12.00-20 20PR				12.00-20 20PR				
	3-5	Wheels, number front / rear (x = driven wheels)				x4 / 2				x4 / 2				
	3-6	Tread, front	b ₁₀	in	mm	72.5		1,842		72.5		1,842		
	3-7	Tread, rear	b ₁₁	in	mm	78.7		2,000		78.7		2,000		
	DIMENSIONS	4-1	Mast tilt, forward / backward	α/β	deg	deg	15° / 12°				15° / 12°			
4-2		Height, mast lowered	h ₁	in	mm	141		3,568		141		3,568		
4-3		Free lift (top of forks)	h ₂	in	mm	0		0		0		0		
4-4		Lift (top of forks)	h ₃	in	mm	147		3,750		147		3,750		
4-5		Height, mast extended	h ₄	in	mm	213		5,398		213		5,398		
4-7		Height of overhead guard (open cab)	h ₆	in	mm	121.4		3,083		121.4		3,083		
4-7-1		Height of overhead guard (closed cab)	h ₆	in	mm	122.4		3,110		122.4		3,110		
4-7-2		Height of overhead guard (closed cab w/ air cond.)	h ₆	in	mm	122.4		3,110		122.4		3,110		
4-7-3		Height of overhead guard (closed cab w/ strobe light)	h ₆	in	mm	126.2		3,205		126.2		3,205		
4-7-4		Height of overhead guard (closed cab w/ work lights)	h ₆	in	mm	128.3		3,259		128.3		3,259		
4-7-5		Height of overhead guard (closed cab w/ air cond. & strobe light)	h ₆	in	mm	127.4		3,235		127.4		3,235		
4-8		Seat height to seat point index	h ₇	in	mm	74.9		1,903		74.9		1,903		
4-19		Overall length	l ₁	in	mm	269		6,828		269		6,828		
4-20		Length to face of forks	l ₂	in	mm	197		4,998		197		4,998		
4-21		Overall width	b ₂	in	mm	100		2,541		100		2,541		
4-22		Fork dimensions ISO 2331	s/e/l	in	mm	3.5 / 8 / 72		90 / 200 / 1,830		3.5 / 8 / 72		90 / 200 / 1,830		
4-23		Fork carriage type				Standard pin type carriage				Standard pin type carriage				
4-24		Fork carriage width	b ₃	in	mm	98.3		2,496		98.3		2,496		
4-25-1		Distance between fork-arms, minimum (in-in)	b ₅	in	mm	2.8		70		2.8		70		
4-25-2		Distance between fork-arms, maximum (out-out)	b ₅	in	mm	95.3		2,420		95.3		2,420		
4-30		Sideshift	b ₈	in	mm	0		0		0		0		
4-31	Ground clearance, with load, below mast	m ₁	in	mm	10		245		10		245			
4-32	Ground clearance, center of wheelbase	m ₂	in	mm	13		341		13		341			
4-34	Min. aisle width (add load length and clearance)	Ast	in	mm	215		5,473		215		5,473			
4-35	Outside turning radius	W _a	in	mm	180		4,584		180		4,584			
		PERFORMANCE		CUMMINS QSB 4.5 TIER 4F ENGINE										
PERFORMANCE	5-1	Travel speed, with / without load (1)		mph	km/h	17	27	18	29	17	27	18	29	
	5-1-1	Travel speed, with load locked / without load		mph	km/h	On request		On request		On request		On request		
	5-2	Lifting speed, with / without load 126cc pump		ft/min	m/s	81	0.41	91	0.46	81	0.41	91	0.46	
	5-3	Lowering speed with / without load		ft/min	m/s	98	0.50	94	0.48	98	0.50	94	0.48	
	5-5	Drawbar pull - 1 mph 1.6 km/h, with / without load		lb	kN	22,900	109	24,100	111	22,800	108	24,000	111	
	5-6	Drawbar pull - stall, with / without load		lb	kN	25,700	121	26,900	123	25,600	121	26,800	123	
	5-7	Gradeability - 1 mph 1.6 km/h, with / without load		%	%	37	37	37	37	35	35	35	35	
	5-8	Gradeability - stall, with / without load		%	%	42	42	37	37	39	39	35	35	
			PERFORMANCE		CUMMINS QSB 6.7TIER 3 ENGINE									
	5-1	Travel speed, with / without load (1)		mph	km/h	17	27	18	29	17	27	18	29	
	5-1-1	Travel speed, with load locked / without load		mph	km/h	On request		On request		On request		On request		
	5-2	Lifting speed, with / without load 111cc pump		ft/min	m/s	71	0.36	79	0.40	71	0.36	79	0.40	
	5-3	Lowering speed with / without load		ft/min	m/s	98	0.50	94	0.48	98	0.50	94	0.48	
	5-5	Drawbar pull - 1 mph 1.6 km/h, with / without load		lb	kN	20,800	99	22,000	102	20,700	99	21,900	101	
5-6	Drawbar pull - stall, with / without load		lb	kN	23,600	111	24,700	114	23,400	111	24,600	114		
5-7	Gradeability - 1 mph 1.6 km/h, with / without load		%	%	33	33	37	37	31	31	35	35		
5-8	Gradeability - stall, with / without load		%	%	38	38	37	37	50	50	35	35		

General Specifications GDP360EF

GENERAL	1-1	Manufacturer				YALE			
	1-2	Model designation				GDP360EF			
	1-3	Powertrain / drivetrain				Diesel			
	1-4	Operator type				Seated			
	1-5	Rated capacity / rated load	Q	lb	kg	36,000		16,329	
	1-6	Load center distance	c ₁	in	mm	24		610	
	1-8	Load distance	x	in	mm	35		889	
	1-9	Wheelbase	y	in	mm	130		3,300	
	WT.	2-1	Service weight		lb	kg	42,867		19,444
2-2		Axle loading with load, front / rear		lb	kg	72,765	33,006	6,101	2,768
2-3		Axle loading without load, front / rear		lb	kg	20,417	9,261	22,450	10,183
WHEELS	3-1	Tire type				Pneumatic			
	3-2	Tire size, front				12.00-20 20PR			
	3-3	Tire size, rear				12.00-20 20PR			
	3-5	Wheels, number front / rear (x = driven wheels)				x4 / 2			
	3-6	Tread, front	b ₁₀	in	mm	72.5		1,842	
	3-7	Tread, rear	b ₁₁	in	mm	78.7		2,000	
	DIMENSIONS	4-1	Mast tilt, forward / backward	α/β	deg	deg	15° / 12°		
4-2		Height, mast lowered	h ₁	in	mm	141		3,568	
4-3		Free lift (top of forks)	h ₂	in	mm	0		0	
4-4		Lift (top of forks)	h ₃	in	mm	147		3,750	
4-5		Height, mast extended	h ₄	in	mm	213		5,398	
4-7		Height of overhead guard (open cab)	h ₆	in	mm	121.4		3,083	
4-7-1		Height of overhead guard (closed cab)	h ₆	in	mm	122.4		3,110	
4-7-2		Height of overhead guard (closed cab w/ air cond.)	h ₆	in	mm	122.4		3,110	
4-7-3		Height of overhead guard (closed cab w/ strobe light)	h ₆	in	mm	126.2		3,205	
4-7-4		Height of overhead guard (closed cab w/ work lights)	h ₆	in	mm	128.3		3,259	
4-7-5		Height of overhead guard (closed cab w/ air cond. & strobe light)	h ₆	in	mm	127.4		3,235	
4-8		Seat height to seat point index	h ₇	in	mm	74.9		1,903	
4-19		Overall length	l ₁	in	mm	269		6,823	
4-20		Length to face of forks	l ₂	in	mm	197		4,998	
4-21		Overall width	b ₂	in	mm	100		2,541	
4-22		Fork dimensions ISO 2331	s/e/l	in	mm	3.5 / 8 / 72		90 / 200 / 1,830	
4-23		Fork carriage type				Standard pin type carriage			
4-24		Fork carriage width	b ₃	in	mm	98		2,496	
4-25-1		Distance between fork-arms, minimum (in-in)	b ₅	in	mm	2.8		70	
4-25-2		Distance between fork-arms, maximum (out-out)	b ₅	in	mm	95.3		2,420	
4-30		Sideshift	b ₈	in	mm	0		0	
4-31		Ground clearance, with load, below mast	m ₁	in	mm	10		245	
4-32		Ground clearance, center of wheelbase	m ₂	in	mm	13		341	
4-34	Min. aisle width (add load length and clearance)	Ast	in	mm	215		5,473		
4-35	Outside turning radius	W _a	in	mm	180		4,584		
PERFORMANCE	PERFORMANCE		CUMMINS QSB6.7 TIER 4F ENGINE						
	5-1	Travel speed, with / without load (1)	mph	km/h	17	27	18	29	
	5-1-1	Travel speed, with load locked / without load	mph	km/h	On request		On request		
	5-2	Lifting speed, with / without load 126cc pump	ft/min	m/s	81	0.41	91	0.46	
	5-3	Lowering speed with / without load	ft/min	m/s	98	0.50	94	0.48	
	5-5	Drawbar pull - 1 mph 1.6 km/h, with / without load	lb	kN	22,500	108	23,900	111	
	5-6	Drawbar pull - stall, with / without load	lb	kN	25,300	120	26,800	123	
	5-7	Gradeability - 1 mph 1.6 km/h, with / without load	%	%	32	32	38	38	
	5-8	Gradeability - stall, with / without load	%	%	36	36	38	38	
	PERFORMANCE		CUMMINS QSB6.7 TIER 3 ENGINE						
	5-1	Travel speed, with / without load (1)	mph	km/h	17	27	18	29	
	5-1-1	Travel speed, with load locked / without load	mph	km/h	On request		On request		
	5-2	Lifting speed, with / without load 111cc pump	ft/min	m/s	71	0.36	79	0.40	
	5-3	Lowering speed with / without load	ft/min	m/s	98	0.50	94	0.48	
	5-5	Drawbar pull - 1 mph 1.6 km/h, with / without load	lb	kN	20,400	98	21,800	101	
	5-6	Drawbar pull - stall, with / without load	lb	kN	23,200	111	24,600	113	
	5-7	Gradeability - 1 mph 1.6 km/h, with / without load	%	%	29	29	38	38	
	5-8	Gradeability - stall, with / without load	%	%	32	32	38	38	

Powertrains

GENERAL		Yale					
1-1	Manufacturer	GDP300-360EF					
1-2	Model designation	Diesel					
1-3	Powertrain / drivetrain	Cummins / QSB 6.7					
7-1	Engine manufacturer / model	Tier 3 / Stage IIIA					
7-1a	EPA / CE compliance	Tier 3 / Stage IIIA			Tier 4F / Stage IV		
7-2	Engine power output according to ISO 1585	hp	kW	155	116	164	122
7-2-1	Engine power output - Peak	hp	kW	155	116	168	125
7-3	Governed speed	rpm	1/min	2,300			
7-3-1	Engine torque @rpm (1/min)	lb-ft	N-m	440 @ 1500	597 @ 1,500	540 @ 1500	732 @ 1,500
7-4	Number of cylinders / displacement	# / in ³	# / cm ³	6 / 409	6 / 6,700	6 / 409	6 / 6,700
	Turbocharger	Type	Wastegate			Variable geometry, water cooled	
7-8	Alternator output	Amps	120				
7-9	Electrical system voltage	V	24				
7-10	Battery voltage, rated capacity	V / Ah	24 / 102				
8-1	Drive control / Transmission	Type / #	Powershift Transmission				
8-2	Transmission manufacturer / type	Type / #	ZF / WG161				
8-4	Transmission speeds forward / backward	#	3 / 3				
8-5	Coupling	Type	Torque Converter				
8-6	Wheel drive / drive axle manufacturer / type	Type / #	Kessler / D81				
8-11	Service brake	Type	Oil immersed (wet) disc				
8-12	Parking brake	Type	Spring applied, dry disc on drive axle				
10-1	Operating pressure for attachments	psi	l	3,263	22.5	3,263	22.5
10-2	Oil volume for attachments	gal/min	l/min	26.4	100	26.4	100
10-3	Hydraulic tank capacity	gal	l	37	140	37	140
10-4	Fuel tank capacity	gal	l	42	158	42	158
10-4-1	DEF tank capacity	gal	l	NA	NA	5	19
10-5	Steering design	Hydraulic power steering					
10-6	Number of steering rotation	4.5					
10-7	Sound pressure level at driver's seat (2)	Lpaz	dB(A)	72.3			
10-7-1	Sound power level during the working cycle (2)	Lwaz	dB	106.5			
10-8	Towing coupling, model / type	Yes / Pin					

Notes:

Specifications are affected by the condition of the vehicle and how it is equipped, as well as the nature and condition of the operating area. Inform your dealer of the nature and condition of the intended operating area when purchasing your Yale® truck.

- (1) Travel speed laden/unladen limited at 15.5 mph / 25 km/h as factory default
- (2) T4 engine based on low mount exhaust.

All capacities are according to EN1459.

All specifications and capacities are valid for trucks equipped with a Yale® container handling spreader for handling ISO containers.

CE Safety: This truck conforms to the current EU and ANSI requirements.

Notice:

Care must be exercised when handling elevated loads. Operators must be trained and must read, understand and follow the instructions contained in the Operating Manual.

All values are nominal values and they are subject to tolerances. For further information, please contact the manufacturer.

Yale products are subject to change without notice.

Lift trucks illustrated may feature optional equipment. Values may vary with alternative configurations.

CERTIFICATION: Yale lift trucks meet the design and construction requirements of B56.1-1969, per OSHA Section 1910.178(a)(2), and also comply with the B56.1 revision in effect at time of manufacture. Certification of compliance with the applicable ANSI standards appears on the lift truck. Performance specifications are for a truck equipped as described under Standard Equipment on this Technical Guide. Performance specifications are affected by the condition of the vehicle and how it is equipped, as well as by the nature, condition of the operating area, proper service and maintenance of the vehicle. If these specifications are critical, the proposed application should be discussed with your dealer.

NOTE: Specifications, unless otherwise listed, are for a standard truck without optional equipment.

Specification data is based on VDI 2198.

RATED CAPACITY LB: GDP300-330EF @ 24 IN LOAD CENTER

2 stage NFL	4-4 Lift height TOF		4-4 Lift height BOF		4-2 Overall lowered height		4-5 Overall extended height		Mast max roller lap (retracted) (variable lap) 'l_max'		Mast max roller lap (extended) (variable lap) 'l_max'		Mast weight		Standard Pin Type carriage				Apron Pin Type carriage				QD DFSSFP Carriage			
	GDP300EF		GDP330EF		GDP300EF		GDP330EF		GDP300EF		GDP330EF		GDP300EF		GDP330EF		GDP300EF		GDP330EF		GDP300EF		GDP330EF			
	in	mm	in	mm	in	mm	in	mm	in	mm	in	mm	lb	kg	lb	kg	lb	kg	lb	kg	lb	kg	lb	kg	lb	kg
108	2750	104	2660	121	3068	174	4398	100	2520	47	1190	5567	2525	30,000	13,600	33,000	15,000	30,000	13,600	33,000	15,000	29,400	13,300	32,400	14,700	
118	3000	114	2910	126	3193	183	4648	105	2645	47	1190	5730	2599	30,000	13,600	33,000	15,000	30,000	13,608	33,000	15,000	29,400	13,300	32,400	14,700	
128	3250	124	3160	131	3318	193	4898	110	2770	47	1190	5900	2676	30,000	13,600	33,000	15,000	30,000	13,608	33,000	15,000	29,400	13,300	32,400	14,700	
137	3500	134	3410	136	3443	203	5148	114	2895	47	1190	6065	2751	30,000	13,600	33,000	15,000	30,000	13,608	33,000	15,000	29,400	13,300	32,400	14,700	
147	3750	144	3660	141	3568	213	5398	119	3020	47	1190	6235	2828	30,000	13,600	33,000	15,000	30,000	13,608	33,000	15,000	29,400	13,300	32,400	14,700	
157	4000	153	3910	146	3693	223	5648	124	3145	47	1190	6398	2902	30,000	13,600	33,000	15,000	30,000	13,608	33,000	15,000	29,400	13,300	32,400	14,700	
177	4500	173	4410	156	3943	243	6148	134	3395	47	1190	6733	3054	30,000	13,600	33,000	15,000	30,000	13,608	33,000	15,000	29,400	13,300	32,400	14,700	
187	4750	183	4660	161	4068	252	6398	139	3520	47	1190	7022	3185	30,000	13,600	33,000	15,000	30,000	13,608	33,000	15,000	29,400	13,300	32,400	14,700	
196	5000	193	4910	166	4193	262	6648	144	3645	47	1190	7194	3263	30,000	13,600	33,000	15,000	30,000	13,608	33,000	15,000	29,400	13,300	32,400	14,700	
216	5500	213	5410	175	4443	282	7148	154	3895	47	1190	7873	3571	29,600	13,400	32,600	14,790	29,600	13,400	32,500	14,740	29,000	13,150	32,300	14,650	
236	6000	232	5910	185	4693	302	7648	164	4145	47	1190	8210	3724	29,200	13,240	32,200	14,600	29,100	13,200	32,000	14,510	29,000	11,570	31,000	14,060	
246	6250	242	6160	190	4818	311	7898	169	4270	47	1190	8384	3803	29,000	13,150	3,900	14,470	28,900	13,100	31,800	14,420	29,000	10,570	23,400	10,610	
255	6500	252	6410	195	4943	321	8148	174	4395	47	1190	8552	3879	28,800	13,060	31,700	14,380	28,600	12,970	31,500	14,290	29,000	9,620	21,200	9,620	
275	7000	272	6910	205	5193	341	8648	183	4645	47	1190	9017	4090	28,300	12,830	31,200	14,150	28,000	12,700	30,900	14,020	29,000	7,940	17,400	7,890	

RATED CAPACITY LB: GDP360EF @ 24 IN LOAD CENTER

2 stage NFL	4-4 Lift height TOF		4-4 Lift height BOF		4-2 Overall lowered height		4-5 Overall extended height		Mast max roller lap (retracted) (variable lap) 'l_max'		Mast max roller lap (extended) (variable lap) 'l_max'		Mast weight		Standard Pin Type carriage		Apron Pin Type carriage		QD DFSSFP Carriage		
	GDP360EF		GDP360EF		GDP360EF		GDP360EF		GDP360EF		GDP360EF		GDP360EF		GDP360EF		GDP360EF		GDP360EF		
	in	mm	in	mm	in	mm	in	mm	in	mm	in	mm	lb	kg	lb	kg	lb	kg	lb	kg	lb
108	2750	104	2660	121	3068	174	4398	100	2520	47	1190	5567	2525	36,000	16,330	36,000	16,330	35,400	16,060		
118	3000	114	2910	126	3193	183	4648	105	2645	47	1190	5730	2599	36,000	16,330	36,000	16,330	35,400	16,060		
128	3250	124	3160	131	3318	193	4898	110	2770	47	1190	5900	2676	36,000	16,330	36,000	16,330	35,400	16,060		
137	3500	134	3410	136	3443	203	5148	114	2895	47	1190	6065	2751	36,000	16,330	36,000	16,330	35,400	16,060		
147	3750	144	3660	141	3568	213	5398	119	3020	47	1190	6235	2828	36,000	16,330	36,000	16,330	35,400	16,060		
157	4000	153	3910	146	3693	223	5648	124	3145	47	1190	6398	2902	36,000	16,330	36,000	16,330	35,400	16,060		
177	4500	173	4410	156	3943	243	6148	134	3395	47	1190	6733	3054	36,000	16,330	36,000	16,330	35,400	16,060		
187	4750	183	4660	161	4068	252	6398	139	3520	47	1190	7022	3185	36,000	16,330	36,000	16,330	35,400	16,060		
196	5000	193	4910	166	4193	262	6648	144	3645	47	1190	7194	3263	36,000	16,330	36,000	16,330	35,300	16,010		
216	5500	213	5410	175	4443	282	7148	154	3895	47	1190	7873	3571	35,600	16,150	35,600	16,150	31,400	14,240		
236	6000	232	5910	185	4693	302	7648	164	4145	47	1190	8210	3724	35,100	15,920	35,100	15,920	25,800	11,700		
246	6250	242	6160	190	4818	311	7898	169	4270	47	1190	8384	3803	34,900	15,830	34,800	15,790	23,400	10,610		
255	6500	252	6410	195	4943	321	8148	173	4395	47	1190	8552	3879	34,700	15,740	34,500	15,650	21,000	9,530		
275	7000	272	6910	205	5193	341	8648	183	4645	47	1190	9017	4090	34,200	15,510	33,900	15,380	17,200	7,800		

All above capacities are calculated using 48" x 3" x 8" forks

Capacity Ratings

**RATED LOAD VS. LOAD CENTER | STD PIN TYPE
U.S. CUSTOMARY**

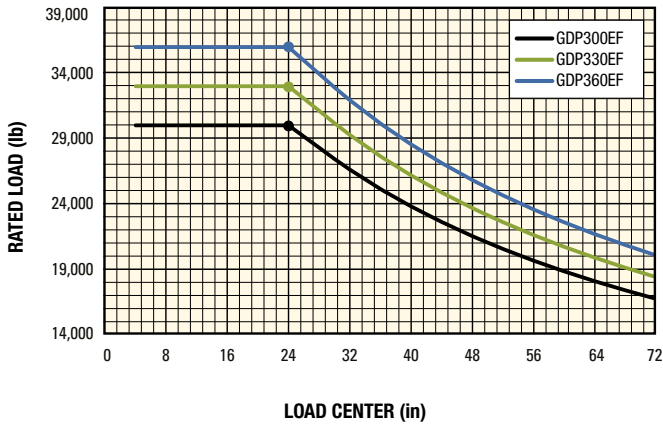

**RATED LOAD VS. LOAD CENTER | PIN TYPE WITH FP
U.S. CUSTOMARY**

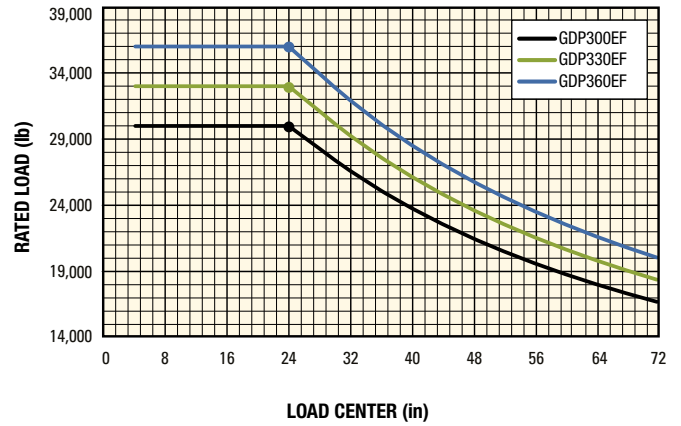

**RATED LOAD VS. LOAD CENTER | INTEGRAL & APRON FP
U.S. CUSTOMARY**

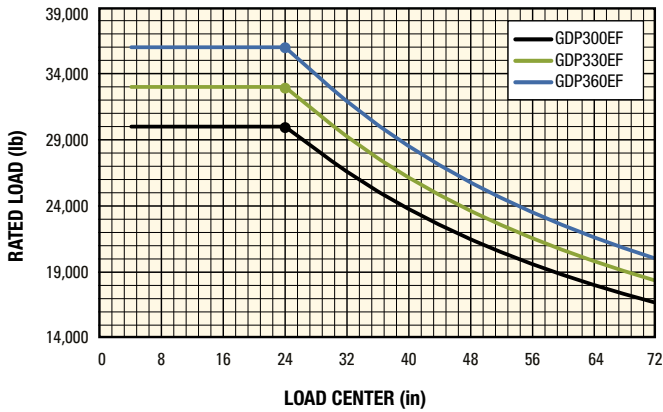

**RATED LOAD VS. LOAD CENTER | DFSSFP
U.S. CUSTOMARY**

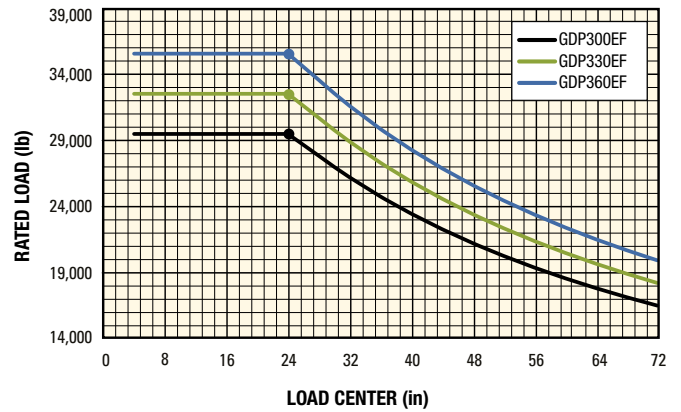

Conversion Factor: 1.0" = 25.4 mm 1 lb = 0.45 kg

Capacities are calculated using 48" x 3" x 8" forks

Contact your dealer for other capacity information.

Features and Options

PERFORMANCE	STD	OPT
Cummins QSB 6.7L Tier 4F diesel engine 164 hp (122 kW)*	X	
Cummins QSB 6.7L Tier 3 diesel engine 155.6 hp (116 kW)*	X	
Tier 4 / Stage IV compliant*	X	
Tier 3 / Stage III compliant*	X	
Variable geometry turbocharger, water cooled*	X	
Wastegate turbocharger*	X	
On-demand cooling fan*	X	
120 amp alternator	X	
Performance modes	X	
Powertrain protection system	X	
Heavy duty air intake	X	
Heavy duty air intake (raised)		X
Low mount exhaust (below chassis)*	X	
High mount exhaust		X
ZF Transmission WG161 3-speeds forward/3-speeds reverse auto-shifting	X	
Kessler D81 drive axle with wet disc brakes	X	
LIFT	STD	OPT
126cc Dual Pump Hydraulic System*	X	
On-Demand Load Sensing Hydraulic System	X	
Automatic Throttle-up when lifting (in neutral or inching)	X	
Variable lap mast for low roller forces	X	
2 stage Non Free Lift mast	X	
2 Stage Full Free Lift mast		X
3 Stage Full Free Lift mast		X
Mast tilt - 5° Forward / 5° Back		X
Mast tilt - 5° Forward / 6° Back		X
Mast tilt - 5° Forward / 12° Back		X
Mast tilt - 15° Forward / 10° Back		X
Mast tilt - 15° Forward / 12° Back	X	
Mast tilt - 20.5° Forward / 7° Back		X
Hydraulic Accumulator		X
Pressure Compensated Lowering	X	
Hydraulic system temperature protection		X
DRIVE	STD	OPT
Speed limiter - unconditional and customer adjustable		X
Travel speed limiter - loaded (adjustable)		X
12.00 - 20 20PR Trelleborg Pneumatic Bias Ply drive and steer tires	X	
12.00 - R20 Michelin XZM Radial drive and steer tires		X
12.00 - R20 Trelleborg Radial drive and steer tires		X
12.00 - 20 Pneumatic Shaped Solid drive and steer tires		X
10.00 - 20 Pneumatic Shaped Solid drive and steer tires		X
HANDLING	STD	OPT
Mast Tilt Indicator - Mechanical		X
98.3" (2496mm) Pin type carriage with mechanical fork locks	X	
98.3" (2496mm) Pin type carriage with simultaneous and independent fork positioner		X
98.3" (2496mm) Pin type apron-style sideshift carriage		X

98.3" (2500mm) Pin type apron-style sideshift carriage with simultaneous fork positioner		X
98.3" (2496mm) Pin type apron-style sideshift carriage with simultaneous and independent fork positioner		X
98.3" (2498mm) QD Hook type dual function sideshift carriage with simultaneous and Independent fork positioner		X
98.3" (2498mm) QD Hook type dual function sideshift carriage with simultaneous fork positioner and 2 auxiliary functions		X
72" (1824mm) High load backrest		X
80" (2040mm) High load backrest		X
98" (2500mm) High load stabilizer (for lumber applications)		X
72" Long x 3.5" Thick x 7.9" Wide (1830mm x 90mm x 200mm) Forks	X	
Pin type forks (various sizes)		X
Pin type forks for lumber applications		X
Hook type quick disconnect DFSSFP forks (various sizes)		X
ERGONOMICS	STD	OPT
Open operator compartment (without doors & screens)	X	
Enclosed operator cabin		X
Powered tilt operator compartment for service		X
Manual tilt operator compartment for service	X	
Isolated mounting for low noise and vibration	X	
Operator presence system	X	
Mechanical suspension seat	X	
Air suspension seat		X
Deluxe air suspension seat		X
Low backrest seat	X	
High backrest seat		X
Additional armrest on left side	X	
Cloth seat cover		X
Vinyl seat cover	X	
Seat heating		X
Seat ventilation		X
2-point high visibility seatbelt	X	
3-point high visibility seatbelt		X
Lateral seat sliding mechanism		X
Floor mat	X	
Coat hook	X	
Interior dome light	X	
Front, top and rear wipers		X
"H"-pattern front wiper		X
"I"-pattern front wiper		X
Laminated glass operator compartment front window		X
Tinted operator compartment windows (all)		X
Tinted operator compartment top window		X
Rain top		X
Plexiglass shield in front of front window		X
Wire mesh installed on top of operator compartment		X
Vertical steel bar front window guard		X
Operator shield wire mesh		X

7" Integrated Performance Display	X	
Touchpoint™ mini levers hydraulic control integrated in Control Arm	X	
Joystick hydraulic control integrated in Control Arm		X
Steering wheel without spinner knob	X	
Steering wheel with spinner knob		X
Directional control lever	X	
Foot directional control pedal		X
Directional Control On Mini-levers or Joystick		X
Park brake - manual	X	
Park brake - automatic		X
Interior wide angle mirrors	X	
Heater with adjustable speed fan		X
Diesel fueled cabin heater		X
Telescoping & tilting steering column	X	
USB outlet inside armrest	X	
24-12 DC converter with 1 socket and 2 USB outlets	X	
24-12 DC converter with 2 sockets and 2 USB outlets		X
Sun visors front window		X
Trainer seat		X
Recirculation fan		X
Additional recirculation fan		X
Accessory Mounting Bar on Cab Front Right Pillar		X
Document holder on Cab Front Right Pillar		X
Heated top- and/or rear window		X
Radio preparation set-up (wiring, two speakers and antenna)		X
VISIBILITY	STD	OPT
Steel bars on top of cab (open operator compartment)	X	
Top window with armoured glass - FOPS certified (enclosed operator cabin)	X	
Steel bars under armoured glass top window (enclosed operator cabin)		X
Exterior mirrors mounted to cab		X
Rear view camera system		X
Halogen work lights		X
High Performance LED work lights		X
Two head lights mounted on front fenders		X
Four mast mounted work lights		X
Four cabin mounted work lights		X
Two rearward work lights mounted on the cabin		X
LED stop/tail/brake lights	X	
Turn signals, hazard & marker lights (LED)		X
OPERATION	STD	OPT
Air horn 112 dBA		X
Electric air horn 105 dBA	X	
Visible alarm – Amber strobe light, key switch activated		X
Audible alarm – Reverse direction activated 82–102 dB(A), self-adjusting		X
Audible alarm – Reverse direction white noise		X
Forward / reverse motion alarm		X

Blue LED spotlight – rear / front and rear		X
Hydraulic load weighing system		X
Tire pressure monitoring system		X
Automatic climate control shut-off with open door		X
Automatic truck shutdown with timer		X
Preventative maintenance reminder in display		X
Customer CANBUS connection		X
Lockable battery disconnect switch		X
Battery jump start connector (NATO plug)		X
Truck Start with key switch and start button	X	
Operator password (display) for Truck Start		X
Seatbelt Interlock for truck start		X
Power distribution group with fuses	X	
Fuses Partially Replaced by Electric Circuit Breakers		X
Non-lockable fuel cap	X	
Lockable fuel cap		X
Diesel fuel inlet strainer in filler neck		X
24 volt electrical system	X	
Yale Tracker wireless asset management system	X	
Yale Tracker wireless asset management - Access / Verification		X
Yale Tracker wireless asset management - Monitoring		X
Auto greasing system for basic truck & outer mast		X
24 volt electrical system	X	
Engine block heater 110 & 240 volt		X
Steer wheel lug nut protection		X
Rear mud flaps		X
Front mud flaps		X
Lifting eyes - 2 front and 2 rear		X
Wire mesh belly pan		X
Wire mesh and plates belly pan		X
APPERANCE	STD	OPT
Second capacity plate		X
Hyster yellow paint base truck	X	
Special paint base truck		X
Operator compartment special paint (outside only)		X
Hazard warning striping on counterweight		X
SUPPLEMENTAL	STD	OPT
Literature package	X	
Operator's manual	X	
CE certification		X
U.L. Label - Standard Construction	X	
Warranty: 12 Months / 2,000 Hours Parts & Labor manufacturer's warranty		X
Warranty: 12 Months / 2,000 Hours Parts manufacturer's warranty	X	

*Standard or optional in selected markets. Other options available through Special Products Engineering Department (SPED). Contact your local Yale® dealer for details.

RANGE OF 2 STAGE NFL MASTS



RANGE OF PIN TYPE AND HOOK TYPE FORKS



98.5" PIN TYPE STANDARD CARRIAGE



Front End Equipment

98.5" PIN TYPE APRON STYLE SIDESHIFT CARRIAGE WITH SIMULTANEOUS AND INDEPENDENT FORK POSITIONER (FOR LUMBER APPLICATIONS)



98.5" PIN TYPE CARRIAGE WITH SIMULTANEOUS AND INDEPENDENT FORK POSITIONER



98.5" PIN TYPE APRON STYLE SIDESHIFT CARRIAGE



98.5" QD HOOK TYPE DUAL FUNCTION SIDESHIFT WITH SIMULTANEOUS AND INDEPENDENT FORK POSITIONER





YALE MATERIALS HANDLING CORPORATION • P.O. Box 7367, Greenville, NC 27835-7367

www.yale.com Manufactured in our own ISO 9001 and 14001 Registered Facilities

Yale is a Registered Trademark and  is a Registered Copyright. ©Yale Materials Handling Corporation 2019. All Rights Reserved.

Truck performance may be affected by the condition of the vehicle, how it is equipped and the application. Consult your Yale® Industrial Truck Dealer if any of the information shown is critical to your application. Specifications are subject to change without notice. CERTIFICATION: Yale lift trucks meet the design and construction requirements of B56.1-1969, per OSHA Section 1910.178(a)(2), and also comply with the B56.1 revision in effect at time of manufacture. Certification of compliance with the applicable ANSI standards appears on the lift truck.

2275-3K 1/2020 Trucks may be shown with optional equipment.